

COVID-19 OPERATIONAL PLAN FOR SCHOOLS

To ensure each school environment safely applies risk mitigation measures consistent with Public Health guidance and the *Occupational Health and Safety Act* and Regulations. All schools, and district offices, must develop a written COVID-19 Operational Plan to provide the safe environment needed for students and staff. Refer to the *Return to School*, September 2020 document and its appendices for primary support for the requirements listed below. This completed document shall be submitted to Clare Tooley, clare.tooley@nbed.nb.ca for review by **August 26th, 2020**. It will then be signed off by Zoë Watson or John MacDonald and returned to the principal for implementation and distribution.

The following document is intended to provide a check list with spaces for each main topic area along with resources. This will help the plan owner, (school Principal), outline each school's Operational Plan. Communication plans must consider and include staff, students, parents/guardians, visiting community professionals, and public. The District Occupational Health and Safety Coordinator is expected to be the primary support for staff and students. School Joint Health and Safety Committees (JHSCs) should be considered integral to preparations and support for September operations and beyond.

School Name	Apohaqui Elementary School
Principal (Signature)	
School District Official (Signature)	
Plan Implementation Date	September 2020

From October to May, minimum monthly review is required. Principal will sign below to identify when this plan has been reviewed internally (*by the principal or JHSC*) to assess any new risks or changes to regulatory guidelines; and as increased hazards/risk conditions warrant. **Keep this original first page for a record of reviews as the rest of the document may change.**

_____ Name (October Review)	_____ Date	_____ Name (February Review)	_____ Date
_____ Name (November Review)	_____ Date	_____ Name (March Review)	_____ Date
_____ Name (December Review)	_____ Date	_____ Name (April Review)	_____ Date
_____ Name (January Review)	_____ Date	_____ Name (May Review)	_____ Date

COVID-19 OPERATIONAL PLAN FOR SCHOOLS

Utilize this page to track your changes.

Section(s) Updated - <i>(List the section numbers only)</i>	Date Updated
Section 6 – Grade 2 will not have a designated washroom on main floor	September 14, 2020
Section 7 – dismissal order during outdoor recess changed	September 14, 2020
Section 8 – Staff members will wear masks in hallway at all times.	September 14, 2020
Section 2 – ‘Doors are locked at 8:05’	September 28, 2020
Section 4 – Entrance door for 3/4 Surrett = North Entrance	September 28, 2020
Section 14 – updated protocols for Breakfast, milk, and hot lunch	September 30, 2020

Table of Contents – Document Owner will need to update page numbers as required

Section 1 - RATIONALE – Effective Risk Mitigation – Infection and Prevention Controls	Hold “Ctrl” and Click Here	Page 4
Section 2 - Communications	Hold “Ctrl” and Click Here	Page 5
Section 3 - Risk Assessment	Hold “Ctrl” and Click Here	Page 6
Section 4 - Building Access	Hold “Ctrl” and Click Here	Page 7
Section 5 - Screening	Hold “Ctrl” and Click Here	Page 9
Section 6 - Physical Distancing	Hold “Ctrl” and Click Here	Page 11
Section 7 - Transition Times	Hold “Ctrl” and Click Here	Page 14
Section 8 - Cleaning and Disinfection Procedures	Hold “Ctrl” and Click Here	Page 16
Section 9 - Hand Hygiene and Cough / Sneeze Etiquette	Hold “Ctrl” and Click Here	Page 19
Section 10 - Personal Protective Equipment	Hold “Ctrl” and Click Here	Page 22
Section 11 - Occupational Health and Safety Act and Regulation Requirements	Hold “Ctrl” and Click Here	Page 24
Section 12 - Outbreak Management Plan	Hold “Ctrl” and Click Here	Page 26
Section 13 - Mental Health	Hold “Ctrl” and Click Here	Page 27
Section 14 - Additional Considerations	Hold “Ctrl” and Click Here	Page 29

COVID-19 OPERATIONAL PLAN FOR SCHOOLS

Section 1 - RATIONALE – Effective Risk Mitigation – Infection and Prevention Controls

The best prevention controls in a school/district are achieved by first focusing on recommended physical distancing requirements and taking every reasonable step to configure the physical site to apply an appropriate physical distance between people. All must practice appropriate hand hygiene and cough / sneeze etiquette. Once all reasonable options in a category have been exhausted, move to the next category. Refer to table below for clarification.

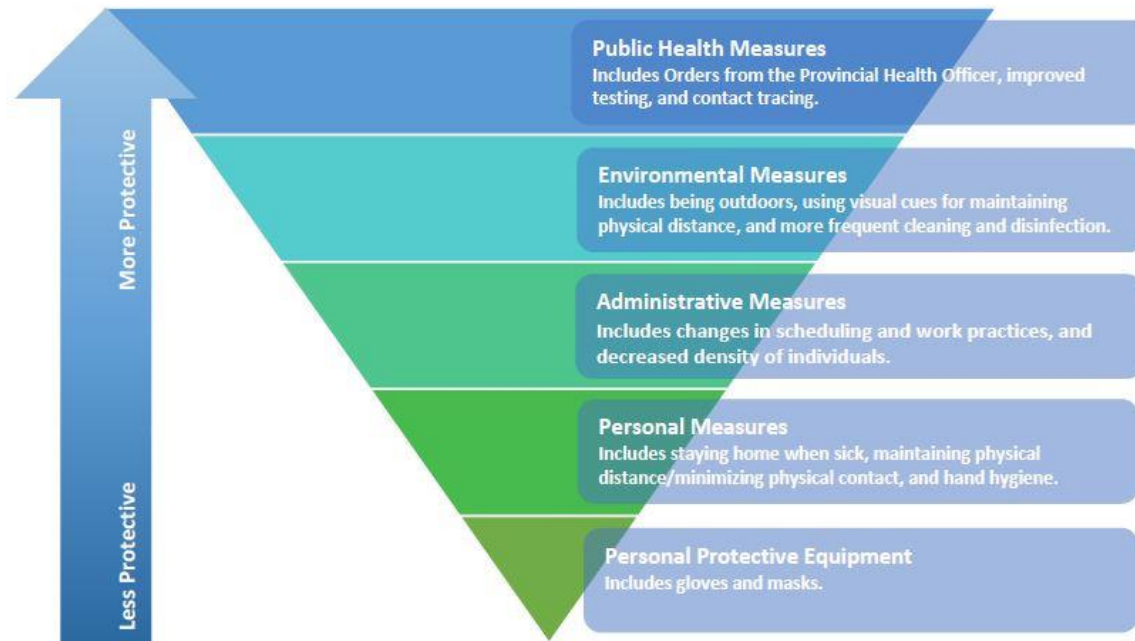

Source: <https://www2.gov.bc.ca/assets/gov/health/about-bc-s-health-care-system/office-of-the-provincial-health-officer/covid-19/covid-19-pho-guidance-k-12-schools.pdf>

In addition to the guidelines and regulations, everyone in the school is responsible for ensuring their own safety and the safety of all others.

Visible signage with clear messaging is a key component to effective communication in the prevention and control of COVID-19.

The K-12 “Return to School September 2020” document is the comprehensive and first reference point for this document.

COVID-19 OPERATIONAL PLAN FOR SCHOOLS

Instructions: Go down the list one-by-one, review the resource materials as applicable. Describe in “Notes” box how you plan to implement the specific items at your school. To help you remember, under the “Status” column, you can select if the section is *done, in progress, not started, or not applicable*. The last column shows the “Date Implemented” so you can track when items are completed.

Action Items	Resources <i>(Examples, Templates, Guidance Documents, Posters, Links, Reference Documents)</i>	Status <i>(Done, In Progress, Not Started, N/A)</i>	Date Implemented
Section 2 - COMMUNICATIONS			
Communicate operational strategies, provide orientation to staff and students.	Refer to Orientation Document for <u>Staff and Students</u> <i>(Will be send out at a later date)</i>	Done	8/13/2020
Communicate operational strategies, provided orientation to visitors.	Visitor Guidelines	Done	8/17/2020
Communicate operational strategies to parent/caregiver and school community.	District Communications Guide for Parents and the Public	Done	8/13/2020

Communication Notes: *Describe how expectations are being communicated to the various stakeholders.*

- Staff orientations and trainings will take place August 31st (teachers, custodian, admin. Assistant) and September 2nd (EAs and other)
- Student orientation will be given at age-appropriate levels within the classroom setting during staggered entry days, September 8th and 9th. Further follow-up will take place in school-wide assembly on September 15th.
- School Connects message will be sent home (following district approval) and Plan will be posted on school website on September 3
- Visitor’s Guide will be sent to families on School Connects and posted on school website. If an appointment is set-up it will be sent in advance of appointment (as a reminder).
- Visitor’s Guide will be printed and left at the Sign-in station at the front entrance.
- [Front door sign](#) – ‘Doors are locked at 8:05. Visitors are admitted by appointment. Call office at 432-2021 or ring bell’
- Signs will be placed on all other [entrance doors](#) – ‘Doors are locked at 8:05 am. All visitors must enter through front entrance ONLY’
- The Visitor’s Guide will be shared with staff, volunteers, and After School Program personnel

COVID-19 OPERATIONAL PLAN FOR SCHOOLS

Action Items	Resources <i>(Examples, Templates, Guidance Documents, Posters, Links, Reference Documents)</i>	Status <i>(Done, In Progress, Not Started, N/A)</i>	Date Implemented
Section 3 - RISK ASSESSMENT			
Complete a risk assessment within the school to determine the risks and identify various controls necessary to mitigate the risk of COVID-19 exposure.	Risk Assessment Document	Done	8/18/2020

Risk Assessment Notes: *Describe that the Risk Assessment has been completed, include a link to it if possible.*

[Risk Assessment](#)
(Linked)

Areas addressed in the following plan according to Risk Assessment document.
 Risk Assessment will be re-visited with staff on September 18th (after 2nd week of school).

COVID-19 OPERATIONAL PLAN FOR SCHOOLS

Action Items	Resources <i>(Examples, Templates, Guidance Documents, Posters, Links, Reference Documents)</i>	Status <i>(Done, In Progress, Not Started, N/A)</i>	Date Implemented
Section 4 - BUILDING ACCESS			
Ensure controls are in place to prevent the public from freely accessing the operational school.	Screening sign, door signs, Info home to parents, All doors locked at 8:15	Done	8/18/2020
<p>Ensure controls are in place to track all people entering the school. Logs must be made available to Public Health for contact tracing purposes if it is identified that a person who tested positive for COVID-19 was present in the school.</p> <p>Attendance is required on a daily basis for staff and students.</p> <p>Schools must track all staff and students leaving the building for extended periods of time for contact tracing purposes.</p> <p>Teachers/Staff who visit multiple schools must keep a log of schools they have been to. Ex: SLP, EAL</p>	<p>Visitor Log set up in school entry (pen and sanitizing wipes included)</p> <p>Admin. Assistant one-pager</p>	Done	8/18/2020
Ensure controls are in place to track internal sports team participants. Schools must also keep a list of what other schools/organizations sports teams were at their school.		NA	NA
<p>Ensure procedures are in place to promote and control physical distancing during the school start and dismissal times.</p> <p><i>*Keep in mind children walking, parent drop off, buses, etc.</i> <i>*Entry only doors/exit only doors, or assigned doors for certain classrooms, or specific pickup/drop off doors.</i></p>	School entrance procedures, start times, dismissal, hallways, parent drop-off	Done	8/18/2020

COVID-19 OPERATIONAL PLAN FOR SCHOOLS

Building Access Notes: Describe how access to the school is being controlled and communicated. All usual security measures must be maintained.

- Parents advised:
 - All doors are locked at 8:05.
 - Access to building will be by appointment only.
 - Admittance will only be after screening, sign-in, and visitor will be escorted to meeting area.
 - Drop-off of articles will be at the front door only where person will be met by a staff member.
 - Students arriving late or during school day must accompanied by adult to Front door.
 - Signs at all entrances to indicate above. (see previous page)
- [Visitor log](#) will be placed inside front door (entry-way) with pen and sanitizer pump.
- Parents, students, and staff will be advised of sign-out procedure on visitor log as well. No one is to leave the building by other exits as sign out is required. Signs on inside of [all exit doors](#) to indicate above. 'All visitors must exit through Front door. Sign-out in Visitor Log required'
- Attendance of students and staff will be taken daily. If leaving during the day, sign out at office is required.
- When students arrive, they are to go into the school, directly to coathooks (following directional signs in halls and physical distancing if necessary), and then to assigned classroom. Students arriving at the school in the morning, by bus or car, will be greeted by a staff member and guided to the entry door assigned. Staff members will be present in hallways/classrooms to monitor/supervise students upon entry. Older siblings can accompany younger ones to classroom if necessary.
- School entrance – start of day (see page 31)
 - K Hoyt, 4/5 Carr, and K/1 Ravn via [North entrance](#)
 - 2 Johnson via [West entrance](#)
 - 3/4 Surret via [North entrance](#)
 - Signs to indicate designated class entrance will be posted on righthand door at each entrance.
- Parent drop-off in driveway close to student entrance door.
 - Reminder to parents: driveway is a drop-off zone only – no parking and blocking driveway. Note that drivers must adhere to school bus flashing lights at all times (even in driveway)!
- At end of day, when students are dressed for dismissal, classes will line up near coathooks (remaining in the bubble) – 4/5 Carr must lineup in classroom to allow other students to pass in hallway. Students will be dismissed by bus order (as announced from Office).
- School dismissal exits
 - K Hoyt, 4/5 Carr and K/1 Ravn via North entrance
 - 2 Johnson via East entrance
 - 3/4 Surret via Front entrance
- Students NOT departing by bus will be accompanied by staff member to the North entrance and West playground area. Parent pick-up will be on West playground or in driveway after bus dismissal. (Arrangements to be made with homeroom teacher).
- After School Program participants will meet Gail on West Playground (outdoor) or gym (indoor).

COVID-19 OPERATIONAL PLAN FOR SCHOOLS

COVID-19 OPERATIONAL PLAN FOR SCHOOLS

Action Items	Resources <i>(Examples, Templates, Guidance Documents, Posters, Links, Reference Documents)</i>	Status <i>(Done, In Progress, Not Started, N/A)</i>	Date Implemented
Section 5 - SCREENING			
<p>Ensure that all staff entering the building understands and implements the screening process.</p> <p>Staff must screen themselves, take their temperatures, before leaving residences. If there are symptoms of COVID, they should not be at school.</p> <p>Students of age can screen themselves or have a parent screen them daily before coming to school.</p>	<p>Refer to Screening Tool</p> <p>Refer to Return to School 2020 Document Pg. 9, 10</p>	Done	8/20/2020
<p>Create a self-isolation space. Isolate people that are symptomatic immediately at the facility. Keep the person isolated, and wearing a mask (<i>medical preferred</i>), to avoid contaminating others until they are picked up. Call 811 or your health care provider as required and comply with the instructions given.</p> <p><i>Where possible, anyone providing care to a symptomatic individual should maintain a distance of 2 metres and wear a medical mask.</i></p>	<p>Refer to Return to School 2020 Document – Appendix K</p>	Done	8/20/2020

Screening Notes: *Outline how screening requirements are being met.*

COVID-19 OPERATIONAL PLAN FOR SCHOOLS

- GNB Up-to-date Screening Poster will be posted on ALL entrance doors and communicated to families by paper copy (first day of school), School Messenger (September 3rd), and posted on school website (September 3rd) and follow-up will happen whenever an update is received.
- Staff have been advised of screening requirements within the orientation given. Staff must self-monitor throughout the day and are aware that should they become symptomatic, they must put on a mask, and go home as soon as possible.
- Students must be screened at home prior to entering the school. School staff will help children to self-monitor throughout the day. If a student becomes symptomatic while at school they must put on a mask and await pickup in our isolation room (maximum 1-hour).
- The Isolation room will be located next to the library. It must be cleaned between each use following procedure within the Standard Cleaning & Disinfection Document.

Action Items	Resources <i>(Examples, Templates, Guidance Documents, Posters, Links, Reference Documents)</i>	Status <i>(Done, In Progress, Not Started, N/A)</i>	Date Implemented
Section 6 - PHYSICAL DISTANCING			
Implement physical distancing protocols. → Classroom, lunchroom, elevators (<i>indicate where to stand within elevator if enough space, mask use, number of persons permitted</i>), staff rooms, locker rooms, workout rooms, coat/boot areas, meeting rooms, washrooms, change rooms, cafeteria, lockers (<i>recommend not to use lockers as much as possible</i>), etc. → Consider staff, students, visiting professionals, parents/guardians, contractors, volunteers, emergency personnel, repair workers, and community members. → Arrange furniture to promote physical distancing requirements (<i>including reception area</i>). Remove furniture if possible. → Provide visual cues on floor, indicate directional movement where appropriate, “no stopping” areas, narrow hallways, arrows, etc. → Determine if installation of physical barriers, such as partitions, is feasible.	Refer to Return to School 2020 Document <i>various sections</i> . Itinerant professional information in Return to School 2020 Document pg. 18 Refer to Chartwells Operational Plan	Done	8/20/2020

COVID-19 OPERATIONAL PLAN FOR SCHOOLS

Plan all assemblies or other school-wide events <i>virtually or outdoors</i> .	Refer to Return to School 2020 Document Pg. 4	Done	8/20/2020
Evaluate options to reduce the number of people required onsite.		Done	8/20/2020
Evaluate the risk of individuals coming closer than two metres. Stairwells, entry and exit points and narrow hallways can present challenges. Consider implementing one-way traffic zones where possible, e.g., one stairwell for walking up, a different one for walking down.	Refer to sample signage	Done	8/20/2020
Perform Evacuation Drills (<i>Fire Drill/Lockdown</i>) as normal as per NB Reg 97-150 School Administration Regulation. *Physical distancing requirements will be lifted during time of evacuation only, provided that it is complete, and students are back to physical distancing or being within their appropriate bubble within a 15-minute timeframe. Physical distancing must be adhered to upon re-entry to the school and masks are encouraged for all staff and students during drills.	NB Reg 97-150	Done	8/20/2020
School layout guide maps to inform students, staff, visitors, and public of school layout (<i>directional flow, assigned entrance/exit doors</i>) are encouraged but not mandatory.	District Facilities (Maps)	Done	8/20/2020

Physical Distancing Notes: *Outline how physical distancing is being supported and communicated.*

Physical Distancing Measures in place:

- Directional arrows and physical distancing signage for hallways and staircases in place. (see page 32 floor plan)
 - One-way main floor hallway (counterclockwise)
 - Lobby area – use ramp to come up, stairs to go down
 - West stairwell to go up to second floor, east stairwell to go down.
 - Second floor movement will be from west to east.
 - Staff will use one-way through office, p/c room, and staffroom. The only exception is if office personnel has to answer the front door.
 - Office area must be clear to approach admin assistant's desk. Visitors will enter and exit from hallway (two-way) with distancing and sign in place to advise to wait until area is unoccupied.

COVID-19 OPERATIONAL PLAN FOR SCHOOLS

- The only two-way hallway is outside K/1 Ravn. 3/4 Surrett homeroom was moved so that hallway coathooks will not be in use. Signage in place to not pass in this hallway, wait until it is unoccupied.

Office area – limit of 2 (signs in place)

P/C room – limit of 2 (signs in place)

Reminder posters can be found throughout the building – hallways, offices, staffroom, etc. (2m distances)

Classrooms

- All classes will maintain the ‘class bubble’ and stay 2m from other ‘bubbles’.
- Extra furniture has been removed.
- Computers/laptops/lpads have been assigned to specific classes so there is no sharing between classrooms.
- Every class will have soap and paper towels for handwashing at classroom sinks.
- The 1m distancing and/or face shield or desk shield will be used when additional teachers enter the homeroom bubble (example: Music, Resource, Guidance & PE)

Library

- Use of library will be restricted to class bubbles only. Times must be scheduled in advance (see schedule on door of library).
- All chairs have been removed.
- Custodian will sanitize doorknobs and heavy-touched surfaces after each class use.

Staffroom

- Limit of 6
- Surfaces, microwave, photocopier, and computer area will be disinfected by user after use.
- Extra furniture has been removed.

ISD Room

- Extra furniture has been removed.
- Surfaces will be disinfected by adult user after use.

Coathooks/Coatroom

- All coathooks are along one-way directional hallways – physical distancing can be maintained outside a class bubble, but passing in these halls should be limited.
- During recess/lunch transition times, class bubbles will be maintained and classes will exit as a group so as not to pass another class in hallway.

Washrooms

- All classes will have designated gender-neutral washrooms (see floor plan of assigned washrooms on page 29-30). Limit of 2 students per washroom at all times, except the multi-stall (K-Hoyt assigned) washroom which will have a limit of 3.
- Signs will be posted on each washroom door to indicate designated washroom.
- Students leaving the classroom bubble to go to the washroom will be required to wear masks in hallways.
- Washroom cleaning will be part of custodial routine (see cleaning and sanitizing document)

Assemblies – will be held virtually or outside

Drills

COVID-19 OPERATIONAL PLAN FOR SCHOOLS

- All students/staff must exit building as soon as possible. Physical distancing will be in place if possible.
- There is only one exit multiple classes will be exiting, this can be managed by 4/5 Carr exiting before K Hoyt (which would normally be the case – older students are quicker). If gym is occupied, Front door will be used as exit (to reduce number classes exiting through North exit).
- Spacing of classes on playground (muster point) will be increased to 2m.
- When classes assemble at muster points, classroom bubbles must be again maintained.
- Evacuation Drill can take place to Atlantic Community Church but we will not enter the building, instead designate areas by class bubbles in the ACC parking lot. In a real emergency, the church has provided meeting areas for each class (to maintain classroom bubbles).

Action Items	Resources <i>(Examples, Templates, Guidance Documents, Posters, Links, Reference Documents)</i>	Status <i>(Done, In Progress, Not Started, N/A)</i>	Date Implemented
Section 7 - TRANSITION TIMES			
Modify School schedule as required to address transition times, break/recess, accessing lockers, lunch, etc., to promote physical distancing and respect student groupings. Provide time for food preparation and mealtimes.	District OHS Coordinator <i>(Guidance)</i> Refer to Return to School 2020 Document Pg. 13, 14, 15	Done	8/20/2020

Transition Times Notes: *Describe how transitioning/staggering is being implemented and maintained. Insert school schedule.*

COVID-19 OPERATIONAL PLAN FOR SCHOOLS

School schedule will not be modified at this time. Changes can be made when bus arrival/departure times are determined.

Student arrival procedures will change as they will go directly into the school to establish classroom bubbles. The 20-minute supervision over bus arrival times (usually 7:40-8:00) cannot happen because the 5 classes of children cannot be kept at 2m distances on the West playground with play occurring and limited supervision. Sending students into the classrooms when each bus arrives will help to alleviate line-ups at handwashing stations/sinks which would be the case if they were to all come in at the same time.

Transition out to recess & lunch playgrounds:

- Classes will leave the building as a group (supervised by staff) to maintain the homeroom bubbles. Students will lineup and be escorted by a staff member to door, except 3/4 which will exit directly through coatroom.
- 2 Johnson exit via West entrance
- 3/4 Surret exit via coatroom/parking lot entrance
- The other 3 homerooms will have to lineup opposite coathooks and exit in the following order so as not to pass in the hallway.
 1. K Hoyt exit via North entrance
 2. K/1 Ravn exit via North entrance
 3. 4/5 Carr exit via Front entrance

Transition in from recess & lunch:

- Classes will lineup in designated area and enter school as a group (supervised by staff members).
- 2 Johnson enter via West entrance
- 3/4 Surret enter via parking lot/coatroom entrance
- The other 3 homerooms will have to enter in the following order:
 1. K Hoyt via North entrance
 2. 4/5 Carr via Front entrance
 3. K/1 Ravn via North entrance

Outside playgrounds (see page 33)

- The Primary (West) playground will have 3 zones:
 - A= play structures, teeter totters, and swings
 - B= soccer field and field games
 - C= pavement and game stations
- The Upper (East) playground will have 2 zones:
 - D= soccer field, field games and swings
 - E= play structures and basketball
- Each homeroom will be assigned a zone. Rotation will be every 3-5 days as determined by the length of the week and weather. A sign will be posted at the bus drop-off zone (outside West entrance) each morning to inform students of the play zone for classes that day.
- Adult supervision will keep bubbled groups apart and maintain physical distancing.

Recess snacks & lunches will be eaten in homeroom bubbles in classrooms and/or outside areas (preferred).

COVID-19 OPERATIONAL PLAN FOR SCHOOLS

Transitions, adult supervision, and playground rotation lengths will be re-evaluated during October review of Operational Plan.

Action Items	Resources <i>(Examples, Templates, Guidance Documents, Posters, Links, Reference Documents)</i>	Status <i>(Done, In Progress, Not Started, N/A)</i>	Date Implemented
Section 8 - CLEANING AND DISINFECTION PROCEDURES			
Ensure a schedule of cleaning and disinfecting as per EECD cleaning and disinfection standards. This document includes day to day custodial operations, cleaning of toys, desks, phys. ed equipment, instruments, shared surfaces, equipment, computers, library books, art supplies, etc.	Refer to Return to School 2020 Document – Appendix G Refer to Table – Make specific for your school Refer to WHMIS Overview Document	Done	8/20/2020

COVID-19 OPERATIONAL PLAN FOR SCHOOLS

<p>Washrooms:</p> <ul style="list-style-type: none"> → Equip with running tap water, liquid soap, paper towel, (<i>forced air dryers in many locations</i>), toilet paper, and garbage containers where needed. → Foot-operated door openers may be practical in some locations. → K-12 Staff and Students - Community masks must be worn whenever physical distancing requirements outlined in the Return to School 2020 Document cannot be maintained. 	<p>Refer to Return to School 2020 Document Pg. 14</p>	<p style="text-align: center;">Done</p>	<p style="text-align: center;">8/20/2020</p>
<p>Implement Bus Cleaning Protocol</p>	<p>Refer to Return to School 2020 Document – Appendix D</p>	<p style="text-align: center;">Done</p>	<p style="text-align: center;">8/20/2020</p>
<p>Implement Outbreak Cleaning & Disinfection Protocol when required (<i>Process, PPE Requirements</i>)</p>	<p>Refer to Return to School 2020 Document – Appendix G</p>	<p style="text-align: center;">Done</p>	<p style="text-align: center;">8/20/2020</p>
<p>Abide by EECD Ventilation Guidelines</p>	<p>Refer to Return to School 2020 Document Pg. 14</p>	<p style="text-align: center;">Done</p>	<p style="text-align: center;">8/20/2020</p>

Cleaning and Disinfection Notes: *Describe the cleaning and disinfection procedures and how they are being managed.*

Hand cleaning posters have been posted in all washrooms. Hand washing procedures will be modeled, practiced and monitored in each classroom.

Custodian will periodically check to ensure washrooms and classroom sinks are adequately stocked with soap, paper towels, etc.

Masks are encouraged when students are in hallways and when using washrooms, except when students are in 'classroom bubble' during transition (to/from outside play). Staff members will wear masks in hallways at all times.

Buses will be cleaned as per the Bus Cleaning Protocol.

COVID-19 OPERATIONAL PLAN FOR SCHOOLS

Cleaning of equipment/frequently touched items and surfaces will be completed as per the Standard Cleaning & Disinfection Document. Sharing of materials within classrooms is discouraged. Items that have been shared (in centers, for example) will require cleaning according to standards. (see [cleaning schedule](#))

Lego, dinky cars, blocks, and other small shared materials within the classroom bubble used daily for 'Soft Start centers' will be disinfected daily with disinfectant spray 362 and left to dry overnight. More thorough cleaning will be done as required at the end of each week (wet items need space and drying time over the weekend).

Computers/laptops/lpads have been distributed in classrooms to avoid movement of these items between bubbles. These items will be disinfected by the student user (adult supervised) after each use.

In the event of an outbreak, we will ensure proper areas are cleaned as per the Outbreak Management Plan.

We will open windows whenever possible and report any issues with ventilation to our facilities team to fix.

COVID-19 OPERATIONAL PLAN FOR SCHOOLS

Action Items	Resources <i>(Examples, Templates, Guidance Documents, Posters, Links, Reference Documents)</i>	Status <i>(Done, In Progress, Not Started, N/A)</i>	Date Implemented
Section 9 - HAND HYGIENE AND COUGH / SNEEZE ETIQUETTE			
<p>Ensure proper hand hygiene is practiced before and after handling objects or touching surfaces.</p> <p>Ensure hand-washing posters are posted in all washrooms. <i>Suggest putting them on doors and walls.</i></p>	<p>See Table 1</p> <p>Refer to Return to School 2020 Document Pg. 11, 12, 13</p> <p>Schools Custodial and District Facilities Management Handwashing Poster</p>	Done	8/20/2020
<p>Ensure availability of all necessary supplies for cleaning and disinfecting.</p> <p>Designate personnel responsible for monitoring supply levels and communicating with administrators when supplies are low.</p>		Done	8/20/2020
<p>Have minimum Health Canada approved hand sanitizer available to use when soap and water is not available.</p> <p>Anyone bringing hand sanitizer to school must ensure it is *FREE OF ADDED SCENTS*</p> <p>Teachers will be in control of the hand sanitizer in classrooms.</p>	<p>Hand Sanitizer Poster</p> <p>Refer to Return to School 2020 Document Pg. 11, 12, 13</p>	Done	8/20/2020
<p>Remind everyone about frequent hand washing and cough/sneeze etiquette.</p>	<p>Coronavirus disease (COVID-19): Prevention and risks</p>	Done	8/21/2020

COVID-19 OPERATIONAL PLAN FOR SCHOOLS

<p>K-12 Staff and Students - Community masks must be worn whenever physical distancing requirements outlined in the Return to School 2020 Document cannot be maintained.</p>	<p>Refer to Return to School 2020 Document – Appendix A Community Mask Poster</p>	<p>Done</p>	<p>8/21/2020</p>
--	---	--------------------	-------------------------

Hand Hygiene and Cough / Sneeze Etiquette Notes: *Describe how the Hand Hygiene and Cough/Sneeze Etiquette procedures are being managed.*

We will have a supply of 362 Cleaner/Disinfectant, Custodian will dilute product and put into pre-labeled bottles. There will be at least 1 bottle available in every classroom within the school. Custodian will monitor supply levels.

Each classroom will have a supply of hand sanitizer (alcohol free), however, handwashing at classroom sinks is preferred. Soap and paper towels will be provided at every classroom sink.

All staff and students are required to have a community mask readily available. Masks are to be worn when the staff or student leaves the classroom (except during outside transition when students are in homeroom bubbles) and must remain on until they re-enter a classroom.

Students will receive age-appropriate education regarding use of mask, hand washing, sneeze/cough etiquette, and sanitizing of hand and equipment as required.

Staff members will receive training on the above measures during orientation August 31st.

Table 1

COVID-19 OPERATIONAL PLAN FOR SCHOOLS

When Students Should Perform Hand Hygiene	When Staff Should Perform Hand Hygiene
<ul style="list-style-type: none"> on arrival (if not feasible, hand sanitizing is acceptable); before and after meals; after using the toilet; after blowing nose, coughing or sneezing; after playing with shared toys, communal items or learning materials; after handling animals or their waste; before and after taking medications; after playing or learning outside; and whenever hands are visibly dirty. 	<ul style="list-style-type: none"> on arrival (if not feasible, hand sanitizing is acceptable); before and after meals; after using the toilet; after blowing nose, coughing or sneezing; after playing with shared toys, communal items or learning materials; after handling animals or their waste; before and after giving/taking medications; and after playing or learning outside. before and after handling food; after helping a student use the toilet; after breaks; after contact with bodily fluids; after handling garbage; after removing gloves; before and after giving medications; and whenever hands are visibly dirty.

Action Items	Resources <i>(Examples, Templates, Guidance Documents, Posters, Links, Reference Documents)</i>	Status <i>(Done, In Progress, Not Started, N/A)</i>	Date Implemented
Section 10 - PERSONAL PROTECTIVE EQUIPMENT			
To ensure minimal interaction within various set groupings, where feasible and safe, install physical barriers. <i>*To ensure that members of vulnerable populations and students with complex needs are accommodated.</i>	Refer to Return to School 2020 Document – Appendix C, H Itinerant professional information in Return to School 2020 Document pg. 18	Done	8/21/2020
If a child requires to be toileted, the accompanying person(s) if not within the child's regular bubble, must wear community mask(s).		Done	8/21/2020

COVID-19 OPERATIONAL PLAN FOR SCHOOLS

Provide personal protective equipment – only for those situations that require it:			
Provide personal protective equipment for those for whom it has been determined to be necessary, PPE Options:		Done	8/21/2020
Hand protection (gloves)	OHS Guide-PPE	Done	8/21/2020
Eye protection (safety glasses, goggles)	PPE Poster	Done	8/21/2020
Other PPE as determined necessary through the risk assessment (<i>face shield</i>)	District Student Support Services	Done	8/21/2020
Use masks (<i>medical preferred</i>) for individuals who exhibit symptoms of illness to minimize the risk of transmitting COVID-19.	Health Canada information on non-medical masks and face coverings Refer to Return to School 2020 Document – Appendix A Community Mask poster	Done	8/21/2020

Personal Protective Equipment Notes: *Describe how requirements for personal protective equipment are being met and communicated.*

COVID-19 OPERATIONAL PLAN FOR SCHOOLS

Every teacher will have a face shield available. We will supply plexiglass “sneeze guards” for teaching areas upon request and approval. The office reception area will have a plexiglass barrier.

Nitrile gloves will be available for staff as required. EAs involved in toileting will have the equipment required to do so safely. Custodians must wear gloves when cleaning isolation room.

Safety glasses and/or goggles are available to staff who request them.

All teachers will have a face shield to wear when physical distancing cannot be maintained. Note* Community mask must also be worn if a face shield is worn, a face shield does not solely replace a community mask unless deemed necessary through a risk assessment.

Staff members who work within multiple bubbles will wear masks, shields or use desk shields if physical distancing cannot be maintained (Resource, Music, Guidance, PE).

Students/staff who are feeling unwell at the school will be provided with a medical mask which should be discarded after use.

A personal plan will be developed for students who cannot wear a mask due to health conditions or other exceptionalities.

We will have a supply of community masks available for students or staff who forget them.

Custodians will be provided appropriate PPE as per Outbreak Management Plan and OHS standards.

COVID-19 OPERATIONAL PLAN FOR SCHOOLS

Action Items	Resources <i>(Examples, Templates, Guidance Documents, Posters, Links, Reference Documents)</i>	Status <i>(Done, In Progress, Not Started, N/A)</i>	Date Implemented
Section 11 - OCCUPATIONAL HEALTH & SAFETY ACT AND REGULATIONS			
Communicate to all staff and supervisors their responsibilities and rights under the OHS Act and regulations.	OHS Guide-Three Rights Refer to Orientation	Done	8/21/2020
Provide staff and student orientation, information and training on the applicable policies and processes implemented regarding COVID-19.	Refer to Orientation	Done	8/21/2020
Provide staff the employee training on the work refusal process.	Right to Refuse – Refer to Orientation	Done	8/21/2020
Ensure supervisors are knowledgeable of guidelines and processes established by Public Health.	Refer to Orientation	Done	8/21/2020
Ensure all employees receive information, instruction and training on the applicable personal protective equipment required to protect against COVID-19 in the school setting.	Refer to Orientation	Done	8/21/2020
Engage Joint Health & Safety Committee or health and safety representative, if applicable, in the periodic reviews / updates of this document.	OHS Guide-JHSC	In Progress	8/21/2020
Provide competent and sufficient supervision to ensure staff/employees, students, and visitors are complying with policies, procedures and processes established.	OHS Guide topic-Supervision	Done	8/21/2020

COVID-19 OPERATIONAL PLAN FOR SCHOOLS

<p>*School district Human Resources confirm process for addressing employee violations of policies and procedures.</p>	<p>School District HR</p>	<p>Done</p>	<p>8/21/2020</p>
--	---------------------------	--------------------	-------------------------

OH&S Act and Regulations Notes: *Outline how the requirements for OH&S within a COVID response are being met.*

We will review the Orientation with all of our staff and will discuss employee rights, protocol training, right to refuse process/vulnerable persons, etc.

The two Joint Health & Safety representatives, along with custodian and principal, will be involved with the monthly reviews of this Operational Plan. Any concerns about the procedures and/or points of the plan should be expressed to these members in advance of the monthly review which will take place the first week of each month.

COVID-19 OPERATIONAL PLAN FOR SCHOOLS

Action Items	Resources <i>(Examples, Templates, Guidance Documents, Posters, Links, Reference Documents)</i>	Status <i>(Done, In Progress, Not Started, N/A)</i>	Date Implemented
Section 12 - OUTBREAK MANAGEMENT			
<p>Prepare for the possibility that an individual is a suspect COVID-19 case and may have been in the building. Inform your employees of the procedures to be followed and that confidentiality must be maintained. *Regional Public Health will notify the school about what is to be done.</p> <p>Students and staff must self-monitor throughout the day.</p>	<p>WorkSafeNB FAQ - Contact with someone tested/confirmed</p> <p>Refer to Return to School 2020 Document – Appendix K</p>	Done	8/21/2020
<p>Communicate to all staff the requirement to cooperate with Public Health if there is a suspected or confirmed case of COVID-19 in the school.</p> <p>Schools must engage the district from the beginning of the Outbreak Management Process.</p> <p>Regional Public Health will advise the employee, student and parent/guardian, and/or the employer if there is a need to communicate with the school and/or district during contact tracing.</p> <p>Once the district is advised by a staff member who has tested positive for COVID-19, they must then report it to WorkSafeNB.</p>	<p>WorkSafeNB FAQ</p> <p>Refer to Return to School 2020 Document – Appendix K</p>	Done	8/21/2020

COVID-19 OPERATIONAL PLAN FOR SCHOOLS

Outbreak Management Notes: *Outline any specific considerations to outbreak management within your school.*

We will review the Outbreak Management Plan procedures with staff in the Orientation. All applicable stakeholders are aware that Public Health will take the lead in the event of an outbreak. We will follow all protocols outlined in the EECD Outbreak Management Plan.

Appendix K is available to all staff. These protocols will be reviewed monthly at each staff meeting.

Action Items	Resources <i>(Examples, Templates, Guidance Documents, Posters, Links, Reference Documents)</i>	Status <i>(Done, In Progress, Not Started, N/A)</i>	Date Implemented
Section 13 - MENTAL HEALTH			
Provide mental health support to all, including access to an employee assistance program (EAP) or information on public health supports, if available.	Phone: 1-800-663-1142 Accessible toll-free 24/7/365; self-register at www.homeweb.ca <ul style="list-style-type: none"> • Book an appointment or access help right away, including immediate crisis support • Short-term, solution-focused counselling — a client-centered approach to goal setting and problem solving • Bridging to community services, specialized referrals, and treatment if needed • Multilingual diverse clinical network; minimum of master's degree & five years' experience • For employees, spouse/partner, eligible dependents • Voluntary, confidential, no cost to the user Guidelines for Re-Entry into the School Setting During the Pandemic: Managing Social, Emotional and Traumatic Impact NACTATR Guide to School Re-Entry	Done	8/21/2020

COVID-19 OPERATIONAL PLAN FOR SCHOOLS

Mental Health Notes: *Describe how mental health resources will be communicated to staff.*

We will share mental health resources during our orientation. We will periodically make reminders to staff regarding the importance of looking after their mental health and reminding them of resources available.

Action Items	Resources <i>(Examples, Templates, Guidance Documents, Posters, Links, Reference Documents)</i>	Status <i>(Done, In Progress, Not Started, N/A)</i>	Date Implemented
Section 14 - ADDITIONAL CONSIDERATIONS/OTHER			
Ensure schools that provide food abide by applicable regulations.	Return to School document Pg. 13, 14, 15 Refer to GNB Website or GOC Website	In Progress	9/30/2020
External Organizations operating within school <i>(Obtain a copy of their Operational Plan)</i>		Done	8/21/2020
Utilize Bottle refilling stations, or Plan B – Water Coolers, water fountains will be turned off. Put up signage.	Insert Water Bottle Signs	Done	8/21/2020

COVID-19 OPERATIONAL PLAN FOR SCHOOLS

Site Specific Considerations: <ul style="list-style-type: none"> • After School Program • Breakfast Program • Music • Phys Ed • Students with IBSPs 		Done	8/21/2020
--	--	-------------	------------------

Additional Consideration / Other Notes: *Describe how any additional considerations are being met.*

Breakfast Program (start date to be determined)

- All volunteers helping with the Breakfast Program will be required to review and abide by the rules outlined in the school Operational Plan.
- All volunteers will be required to follow food safety protocols and use gloves and face masks when preparing foods for classrooms.
- Foods will be provided in two bins per class, one with refrigerated items and one for shelf-items. Bins will be labelled and returned to designated area following 8:15 O' Canada. Foods will be approved 'grab and go' items (individually wrapped) and/or fresh fruit.
- An adult will be responsible to distribute food to students, wearing gloves, and a community mask. Students will not serve themselves.

Milk and Hot Lunch items will be brought to rooms in labelled classroom containers and distributed by a staff member.

Our After School Program is currently the only external organization within our school. Lisa's Playhouse runs this program and is licensed under the NB Daycare Association. The Operational Plan for this program will be consulted, reviewed, and posted for staff and parent information.

If other organizations use our school, later in the year, we will require the organization to prepare and share an Operational Plan and we will ensure they are aware of our plan as well.

We have turned off all fountains and will only be using bottle fillers. Signage has been posted to remind people not to touch their bottle to the spout as well as a reminder that fountains are closed.

Adjustments will be made to IBSPs for students that are flight-risks or tend to violent tendencies as per use of PPE when physical distancing is not possible.

COVID-19 OPERATIONAL PLAN FOR SCHOOLS

Music and PE protocols will be reviewed and followed.

COVID-19 OPERATIONAL PLAN FOR SCHOOLS

**Classroom Assigned
Washrooms -
Main Floor**

Homeroms

K-Hoyt

K/1 Ravn

3/4 Surrett

4/5 Carr

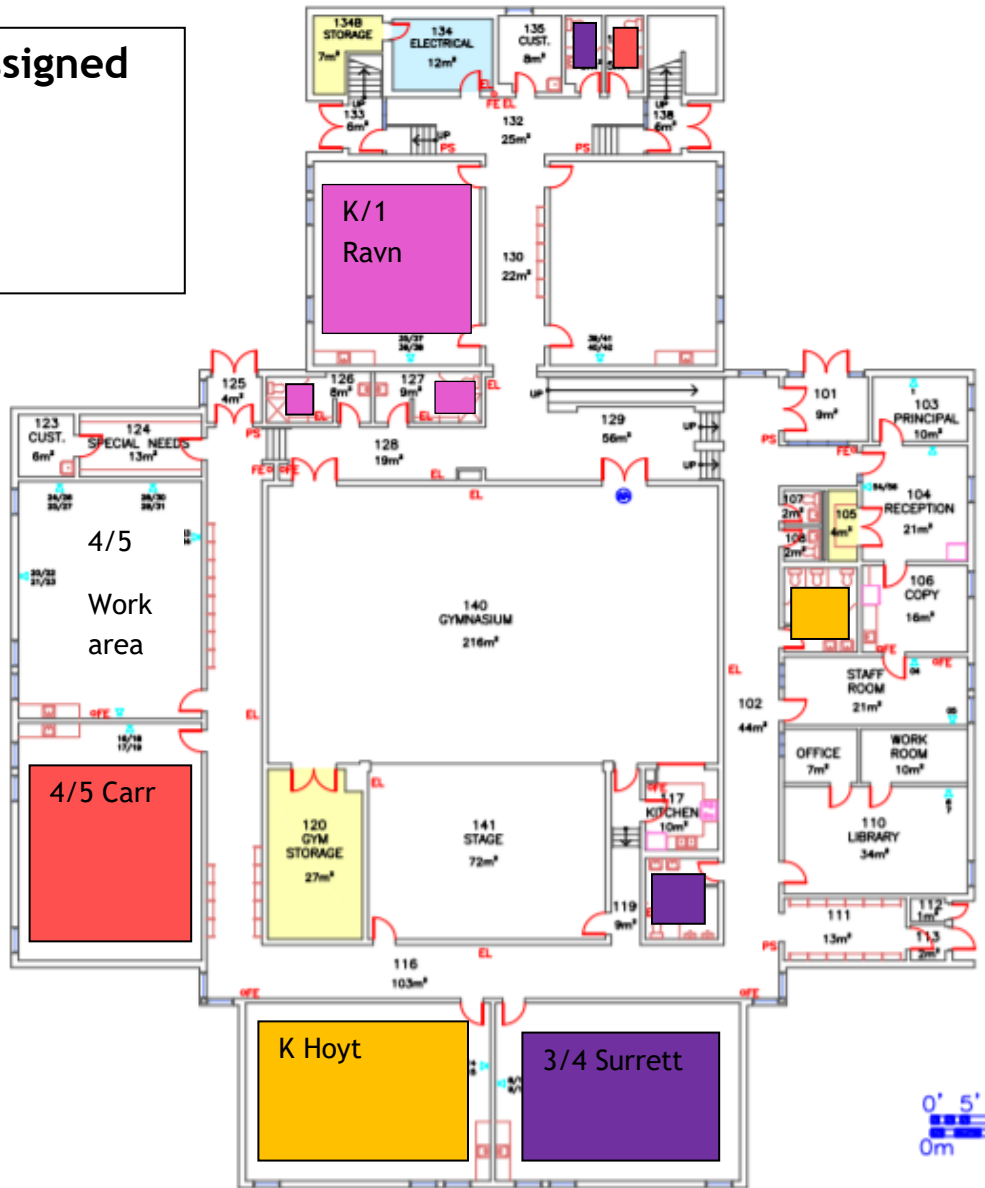

**Classroom Assigned
Washrooms -
2nd Floor**

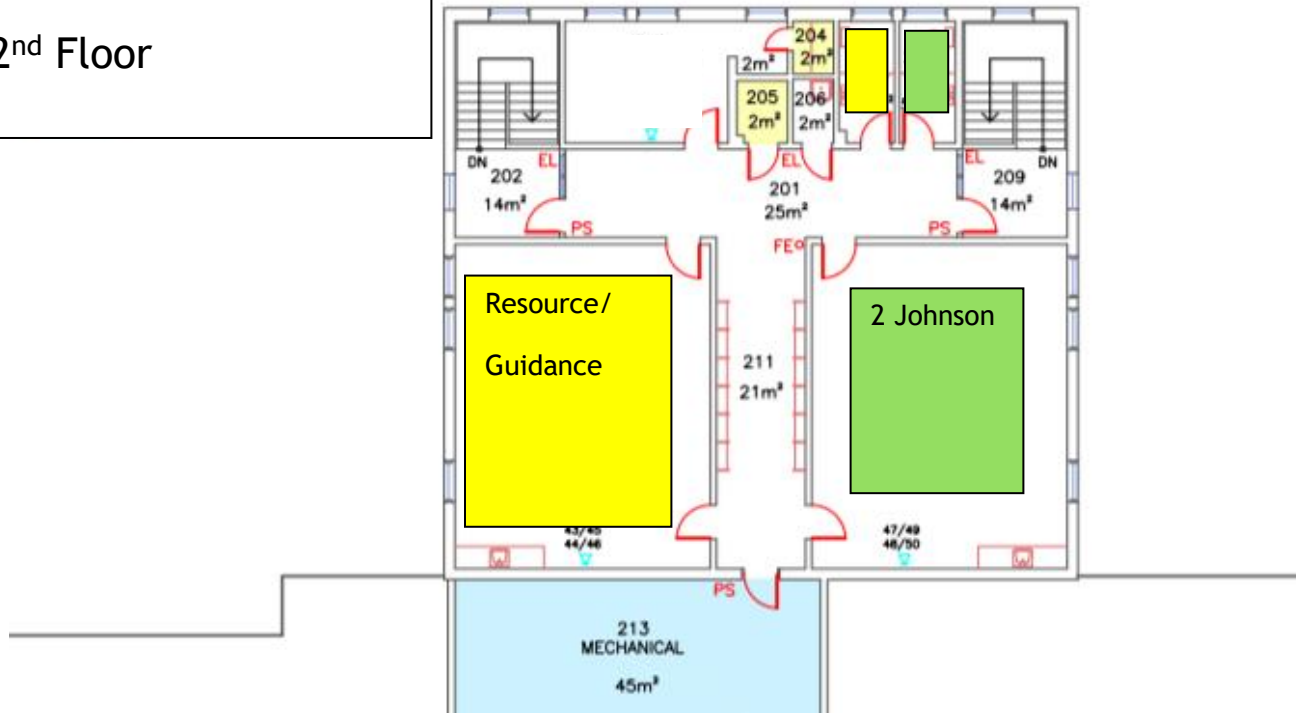

COVID-19 OPERATIONAL PLAN FOR SCHOOLS

MORNING ARRIVAL ENTRANCES

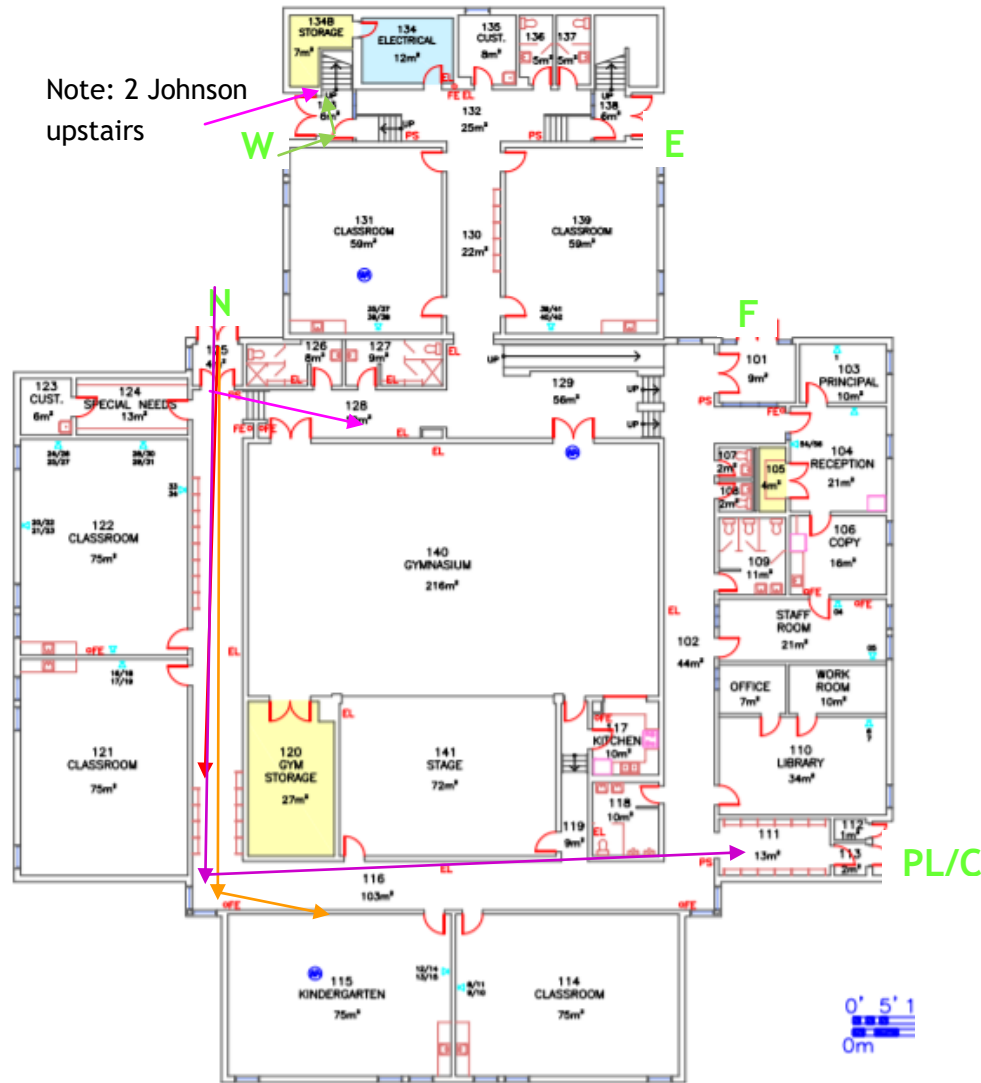

ENTRANCES

N - north

W - west

E - east

F - front

PL/C = parking lot/coatroom

COVID-19 OPERATIONAL PLAN FOR SCHOOLS

Directional flow
(main floor)

Directional flow
(upstairs)

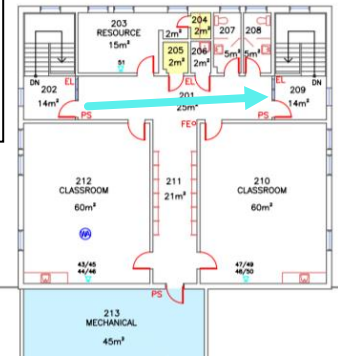
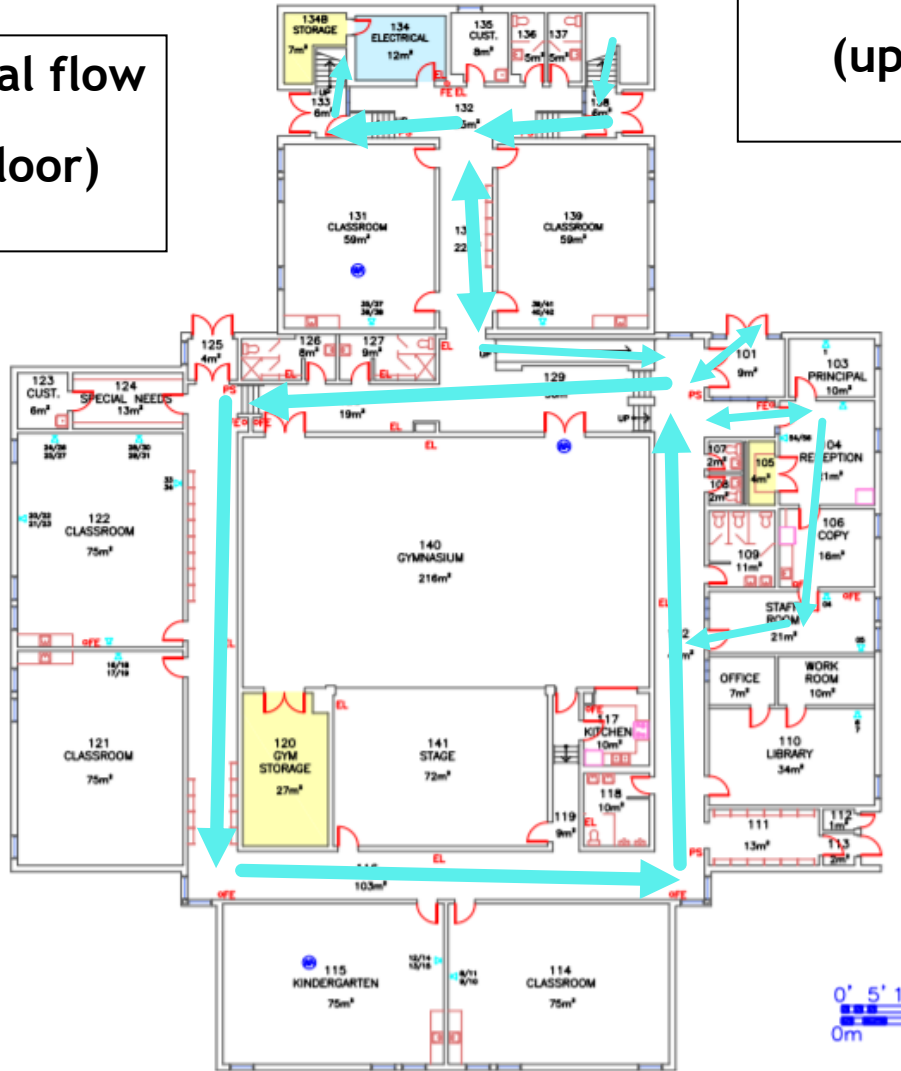

0' 5' 1
0m

COVID-19 OPERATIONAL PLAN FOR SCHOOLS

West Playground
Primary

ZONE B -
soccer & field

ZONE A - swings
& structures

ZONE C -
pavement &
games

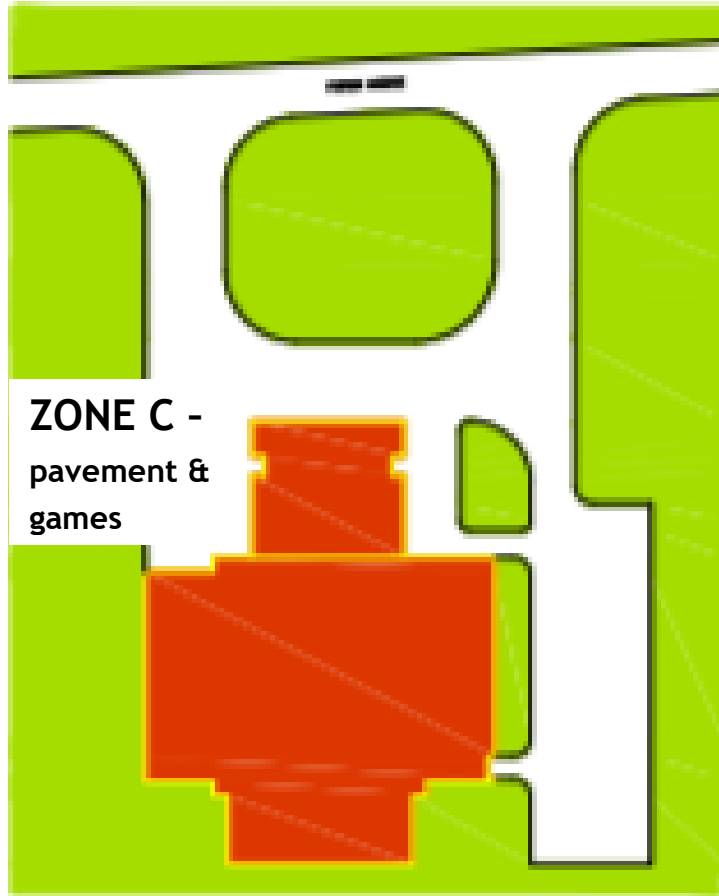

East Playground
Upper
Elementary

ZONE D -
soccer, field &
swings

ZONE E -
structures &
basketball